



Cladding Revo

Revestimientos de madera acetilada



Carbono
negativo y
Renovable



60 años
vida útil mínima
(BRE)*



50 años de
garantía



Libertad de
diseño

Email_ proyectos@leafpanel.com

www.leafpanel.com

LEAF Soluciones



- Revestimiento de madera acetilada -
- 50 años de garantía en exterior -
- 25 años de garantía bajo agua -
- Terminación en impregnante, aceite o natural -
- 100% natural, sin químicos tóxicos -





Elige formato,
largo y color.

- Revestimiento en madera 100% natural, sin químicos tóxicos -
- 50 años de garantía en exterior -
- 25 años de garantía bajo agua -
- Terminación en impregnante o natural -
- Instalación con adhesivo o tornillos -

Revo_

Revestimiento en madera acetilada
Canto redondeado

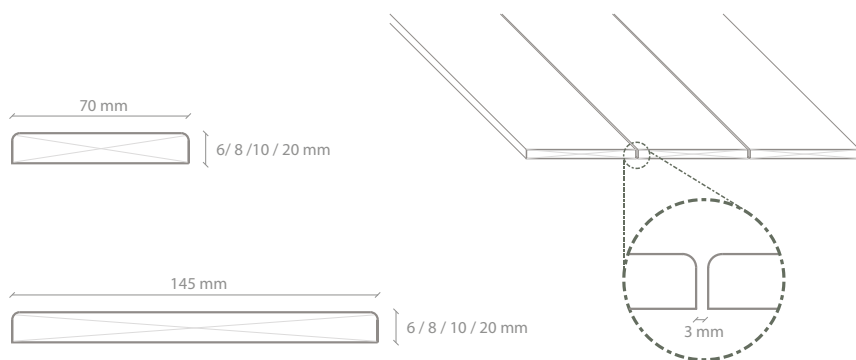

Revo S_

Revestimiento en madera acetilada
Tinglado

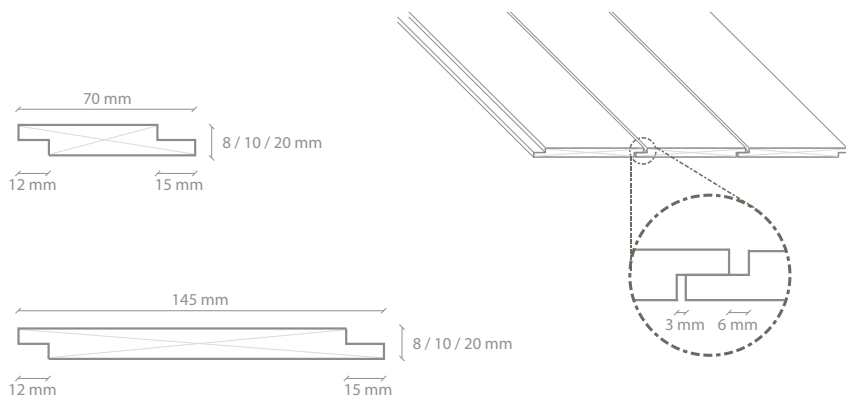

* Para solución Revo y Revo S: Fijar sobre subestructura con distanciamiento de 400 mm entre apoyos.

Largos según disponibilidad_



Línea de color para Revo y Revo S_

Colores Línea Beta



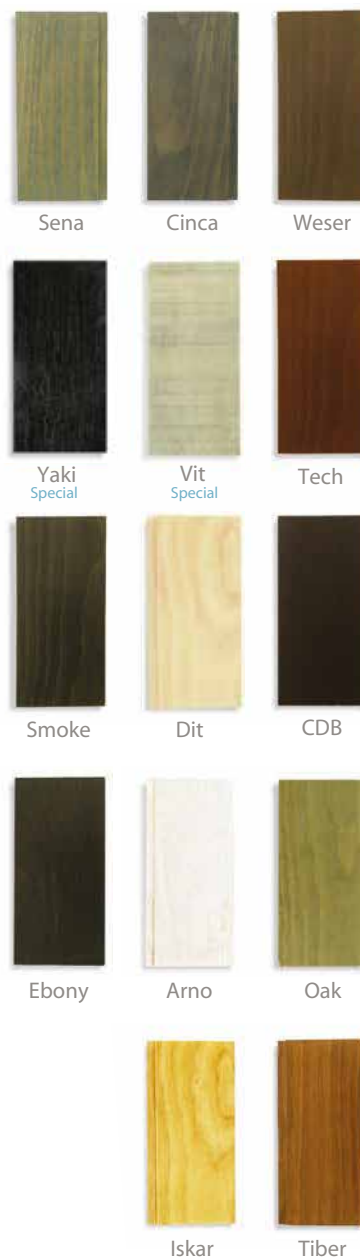

Impregnante y Barniz sobre madera





Rendimiento del producto.

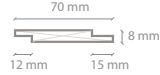

Producto	Formato (mm)	Largo de tabla (mm)	Cantidad de tablas por m2	Rendimiento: m2 x tabla
Revo 6 x 70 	6 x 70	2400	5,7077	0,1752 m2
	6 x 70	3000	4,5662	0,219 m2
	6 x 70	3600	3,8051	0,2628 m2
	6 x 70	4200	3,2615	0,3066 m2
	6 x 70	4800	2,8538	0,3504 m2
Revo 6 x 145 	6 x 70	2400	2,8153	0,3552m2
	6 x 70	3000	2.2522	0,444 m2
	6 x 70	3600	1,8768	0,5328 m2
	6 x 70	4200	1,6087	0,6216 m2
	6 x 70	4800	1,4076	0,7104 m2
Revo 8 x 70 	8 x 70	2400	5,7077	0,1752 m2
	8 x 70	3000	4,5662	0,219 m2
	8 x 70	3600	3,8051	0,2628 m2
	8 x 70	4200	3,2615	0,3066 m2
	8 x 70	4800	2,8538	0,3504 m2
Revo S 8 x 70 	8 x 70	2400	6,9444	0,144 m2
	8 x 70	3000	5,5555	0,18 m2
	8 x 70	3600	4,6296	0,216 m2
	8 x 70	4200	3,9682	0,252 m2
	8 x 70	4800	3,4722	0,288 m2
Revo 8 x 145 	8 x 145	2400	2,8153	0,3552m2
	8 x 145	3000	2.2522	0,444 m2
	8 x 145	3600	1,8768	0,5328 m2
	8 x 145	4200	1,6087	0,6216 m2
	8 x 145	4800	1,4076	0,7104 m2
Revo S 8 x 145 	8 x 145	2400	3,0864	0,324 m2
	8 x 145	3000	2,4691	0,405 m2
	8 x 145	3600	2,0576	0,486 m2
	8 x 145	4200	1,7636	0,567 m2
	8 x 145	4800	1,5432	0,648 m2





* Para cálculo de rendimiento Revo se considera un distanciamiento de 3mm entre tablas.

* Para cálculo de rendimiento Revo Revo S se considera un traslapo de 10 mm entre tablas.

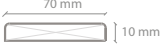
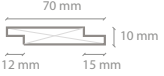

Rendimiento del producto.

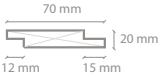

Producto	Formato (mm)	Largo de tabla (mm)	Cantidad de tablas por m2	Rendimiento: m2 x tabla
Revo 10 x 70 	10 x 70	2400	5,7077	0,1752 m2
	10 x 70	3000	4,5662	0,219 m2
	10 x 70	3600	3,8051	0,2628 m2
	10 x 70	4200	3,2615	0,3066 m2
	10 x 70	4800	2,8538	0,3504 m2
Revo S 10 x 70 	10 x 70	2400	6,9444	0,144 m2
	10 x 70	3000	5,5555	0,18 m2
	10 x 70	3600	4,6296	0,216 m2
	10 x 70	4200	3,9682	0,252 m2
	10 x 70	4800	3,4722	0,288 m2
Revo 10 x 145 	10 x 145	2400	2,8153	0,3552m2
	10 x 145	3000	2,2522	0,444 m2
	10 x 145	3600	1,8768	0,5328 m2
	10 x 145	4200	1,6087	0,6216 m2
	10 x 145	4800	1,4076	0,7104 m2
Revo S 10 x 145 	10 x 145	2400	3,0864	0,324 m2
	10 x 145	3000	2,4691	0,405 m2
	10 x 145	3600	2,0576	0,486 m2
	10 x 145	4200	1,7636	0,567 m2
	10 x 145	4800	1,5432	0,648 m2
Revo 20 x 70 	20 x 70	2400	5,7077	0,1752 m2
	20 x 70	3000	4,5662	0,219 m2
	20 x 70	3600	3,8051	0,2628 m2
	20 x 70	4200	3,2615	0,3066 m2
	20 x 70	4800	2,8538	0,3504 m2
Revo S 20 x 70 	20 x 70	2400	6,9444	0,144 m2
	20 x 70	3000	5,5555	0,18 m2
	20 x 70	3600	4,6296	0,216 m2
	20 x 70	4200	3,9682	0,252 m2
	20 x 70	4800	3,4722	0,288 m2

* Para cálculo de rendimiento Revo se considera un distanciamiento de 3mm entre tablas.

* Para cálculo de rendimiento Revo Revo S se considera un traslape de 10 mm entre tablas.



Rendimiento del producto.

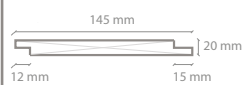

Producto	Formato (mm)	Largo de tabla (mm)	Cantidad de tablas por m2	Rendimiento: m2 x tabla
Revo 20 x 145 	20 x 145	2400	2,8153	0,3552m2
	20 x 145	3000	2.2522	0,444 m2
	20 x 145	3600	1,8768	0,5328 m2
	20 x 145	4200	1,6087	0,6216 m2
	20 x 145	4800	1,4076	0,7104 m2
Revo S 20 x 145 	20 x 145	2400	3,0864	0,324 m2
	20 x 145	3000	2,4691	0,405 m2
	20 x 145	3600	2,0576	0,486 m2
	20 x 145	4200	1,7636	0,567 m2
	20 x 145	4800	1,5432	0,648 m2



* Para cálculo de rendimiento Revo se considera un distanciamiento de 3mm entre tablas.
 * Para cálculo de rendimiento Revo Revo S se considera un traslape de 10 mm entre tablas.



Avenida Los Libertadores/
Lote 15-11/ Parque Industrial
Los Libertadores/ Colina/
Santiago/ Chile.

Tel_ +56 2 3223 3361

Email_ proyectos@leafpanel.com

www.leafpanel.com